



VR3000 F

垂直滚轴输送架



用于窗户元件运输的垂直滚道

- 钢制结构，坚固稳定
- 垂直滚轴输送架可将型材流畅地输送至下一个加工工位并且也可将成品窗户输送至存储和分类工位
- 让窗户元件的搬运更加简便
- 每个滚道单元长3,000 mm
- 上下塑料滑条
- 三个迷你辊道输送机，带橡胶滚轮，直径50 mm
- 带末端支架的基本型号
- 垂直滚轴输送架可借助凸缘滚轮在轨道上移动

选件

- 左右两侧轨道各2.0 m
- 用于VR的末端止挡
- 用于VR的进料滚轮
- 用于支承滚轮的保护器（铝）



垂直滚轴输送架VR 3000 F

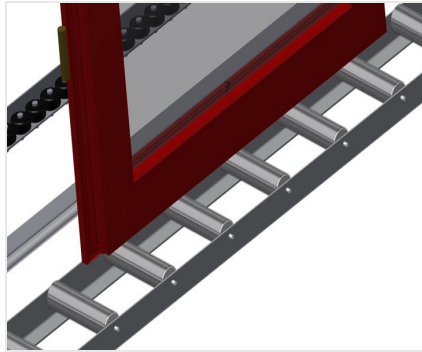

支承滚轮

连续滚轮，支承滚轮宽度200 mm。滚道单元长度2,000 mm，3,000 mm和4,000 mm

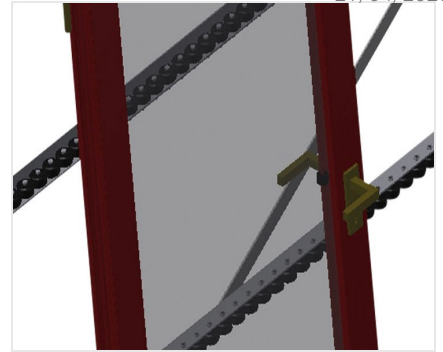

迷你辊道输送机

三个迷你辊道输送机，带橡胶滚轮，直径50 mm



倚靠面

带上下塑料滑条的背面倚靠面

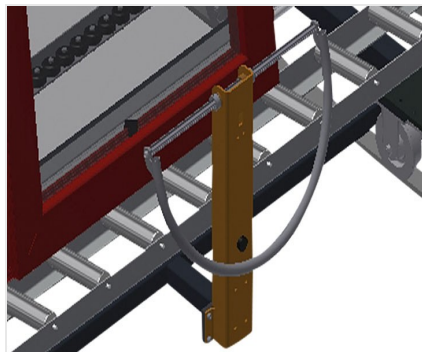

手柄

用于在轨道上轻松移动滚道的手柄

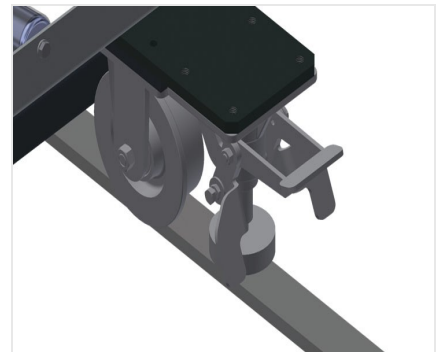

行走单元

带凸缘滚轮和驻车制动器的行走装置



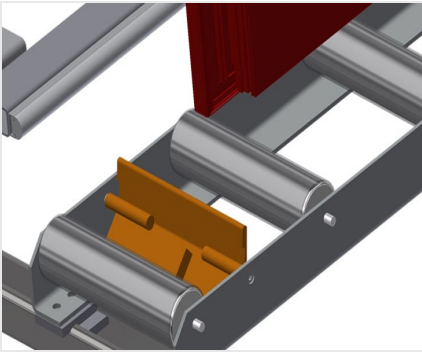

末端止挡

末端止挡Rb = 200 mm, 用于VR

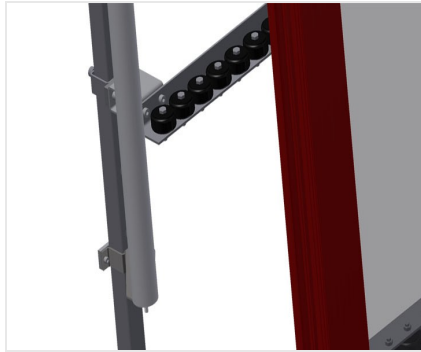

进料滚辊

滚道始端或滚道末端的保护滚轮 L = 500 mm
(一对) L = 250 mm (一对)

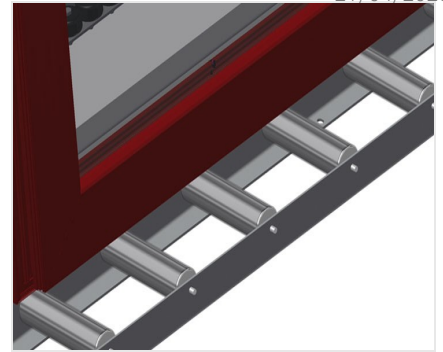

型材保护器

用于支承滚轮的型材保护器200 mm (铝/11 x,
铝/16 x和铝/21 x)。带保护软管的支承滚轮



附加迷你辊道输送机

上下均带橡胶滚轮的附加迷你辊道输送机



轨道

左右两侧轨道各2.0 m





VR 3000 F / □□□□□□

- □3,000 mm
- □1,000 mm
- □2,490 mm
- □□□□200 mm
- □□□□2,100 mm
- □□200 kg
- □140 kg

