

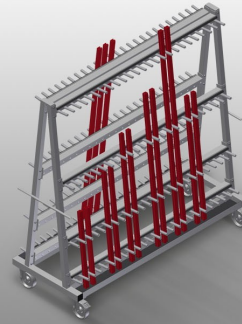

GLW48

玻璃隔板/玻璃压条推车



型材运送车用于铝玻璃压条的垂直存放和运输

- 钢制结构，坚固稳定
- 双侧型材运送车用于玻璃压条的垂直存放和运输
- 可快速拿取已过预先分类的玻璃压条
- 四个带有固定分隔的分类存放架
- 隔架带保护软管
- 下部支承面带保护橡胶
- 带橡胶条的背面倚靠面
- 每侧24个隔层
- 双侧运输架
- 四个转向滚轮，两个带刹车

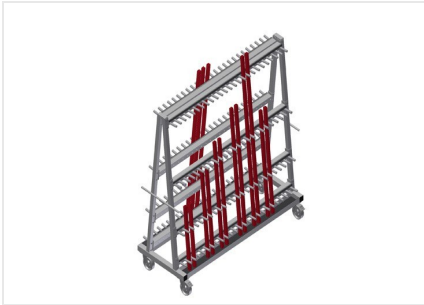

玻璃压条推车GLW 48

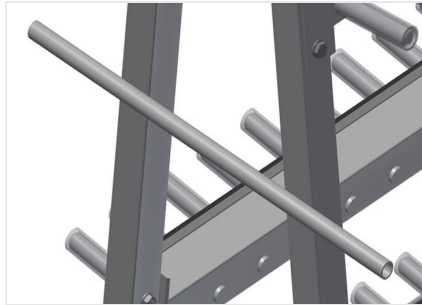

运输架

两侧用于移动的运输架

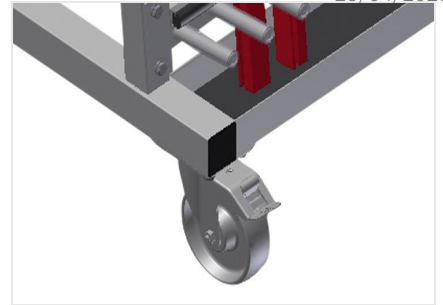

转向滚轮

四个转向滚轮，两个带刹车，实现高机动性并保证轻松、安全的操作

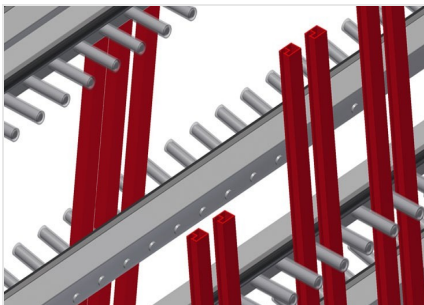

带塑料保护的隔架

所有的支承面均带有防滑PVC涂层，由此可在存放时避免表面发生损坏。

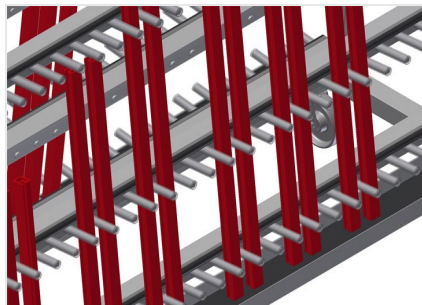

带保护橡胶的支承面

下部支承面带橡胶，保护型材避免损坏

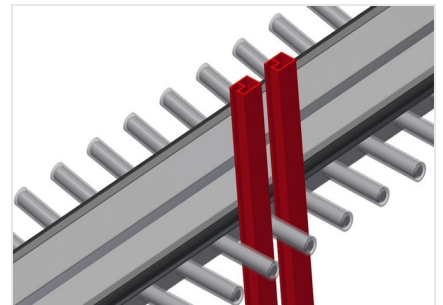

带橡胶条的倚靠装置

倚靠面覆盖橡胶条，保护型材，避免损坏





GLW 48 / □□□□□□□□

- □1,620 mm
- □620 mm
- □1,640 mm
- □□□40 mm
- □□□90 mm
- □□□□1,400 mm
- □120 kg
- □□400 kg
- 48□□□
- 125 mm

