

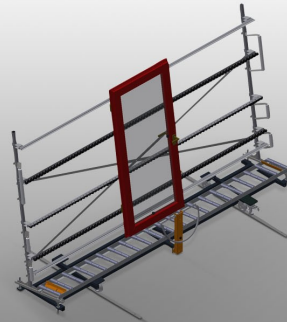

### VR4003 DF

#### VERTICAL ROLLER CONVEYORS



- Stable steel construction
- Vertical roller conveyor for smooth transportation to the next work task as well as for transportation to storage and sorting of the finished windows
- Easy handling of window elements
- Every roller conveyor unit is 4,000 mm long
- Plastic slide bars top and bottom
- Three mini-roller conveyors with rubber rollers, diameter 50 mm
- Basic unit with end rack
- Vertical roller conveyor on rails with flanged rollers, mobile
- Roller conveyor can be rotated 360°

#### Options

- Rail, 2.0 m, left and right
- End stop for VR
- Lead-in roller for VR
- Profile protectors for support rollers (Alum.)



### Vertical roller conveyor with mobility and rotation mechanism VR 4003 DF

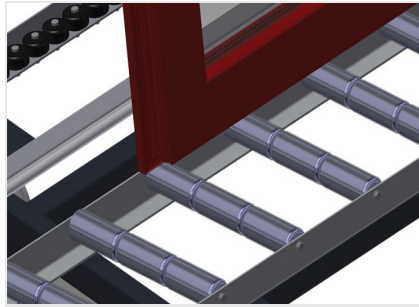

### Support rollers

Rollers throughout, support roller width 3x 120 mm. Roller conveyor unit, 4,000 mm long

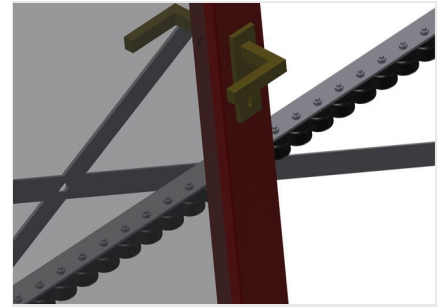

### Mini-roller conveyor

Three mini-roller conveyors with rubber rollers, diameter 50 mm

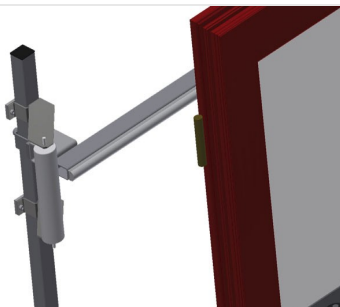

### Support

Rear support with plastic slide bars, top and bottom

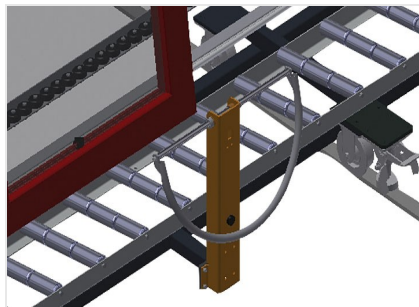

### Grip

Grip makes pushing the roller conveyor on the rails easy

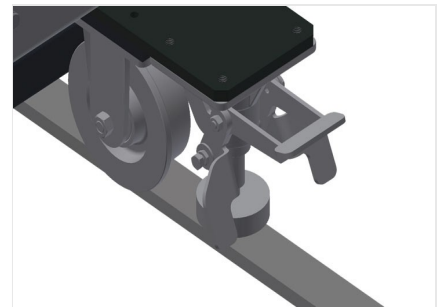

### Mobility unit

Mobility unit with flanged rollers and fixing brake

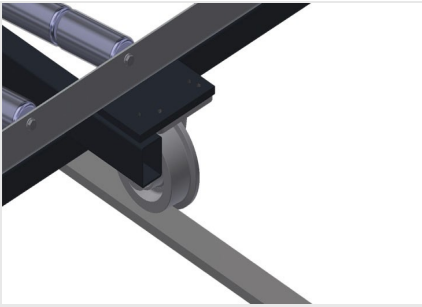

### Rails

Rails, 2.0 m, left and right

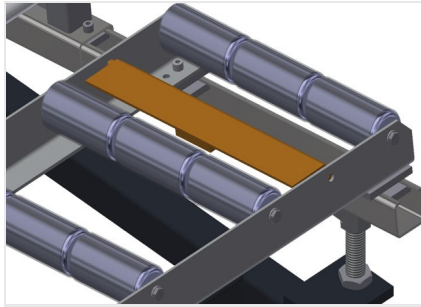

### End stop

End stop Rb=3x120 mm for VR

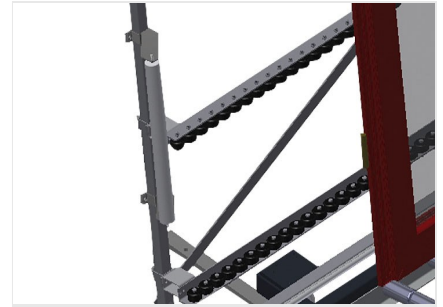

### Lead-in rollers

Protective rollers for beginning or end of roller conveyor

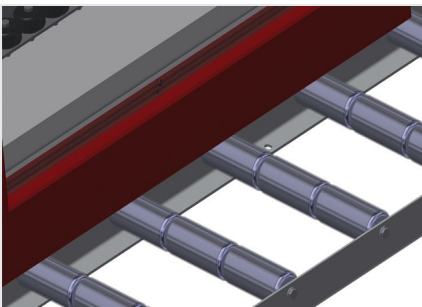

### Profile protectors

Profile protectors for support rollers 3x 120 mm (Alum./48x and Alum./63 x). Support rollers covered with protective tubing



### Additional mini-roller conveyors

Additional mini-roller conveyors with rubber rollers top/bottom





**VR 4003 DF / VERTICAL ROLLER CONVEYORS**

---

- Length 4,000 mm
- Width 1,000 mm
- Height 2,490 mm
- Support rollers divided into three parts 3 x 120 mm
- Unit height 2,100 mm
- Load 200 kg
- Weight 240 kg