

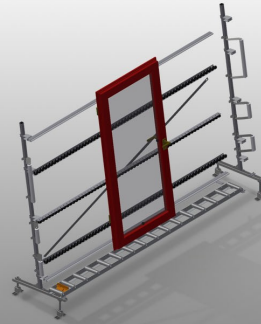

### VR4000

#### Vertical roller conveyors



Vertical roller conveyor for transportation and storage of window elements

- Stable steel construction
- Expandable using modular system design
- Vertical roller conveyor for smooth transportation and storage of window elements
- Easy handling of window elements
- Every roller conveyor unit is 4,000 mm long
- Plastic slide bars top and bottom
- Three mini-roller conveyors with rubber rollers, diameter 50 mm
- Basic unit without end rack

#### Options

- End rack
- End stop
- Lead-in roller
- Profile protectors for support rollers (Alum.)

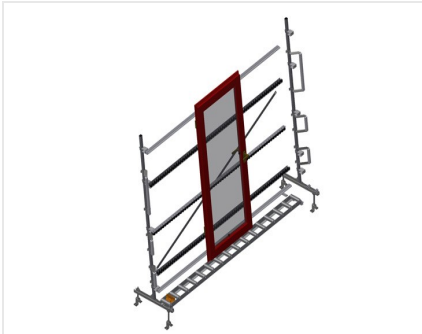

### Vertical roller conveyor VR 4000

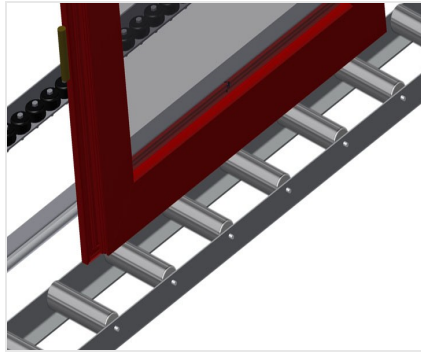

### Support rollers

Rollers throughout, support roller width 200 mm. Roller conveyor units, 2,000, 3,000 and 4,000 mm long



### Mini-roller conveyor

Three mini-roller conveyors with rubber rollers, diameter 50 mm



### Back support

Rear back support with plastic slide bars, top and bottom

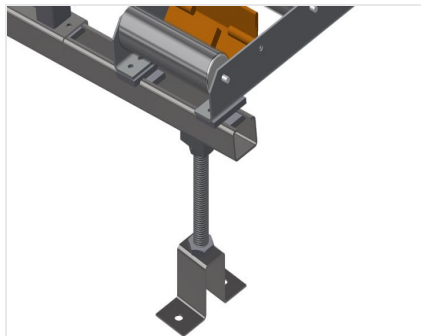

### Roller conveyor height adjustment

Lower roller conveyor height can be adjusted by means of adjustable feet

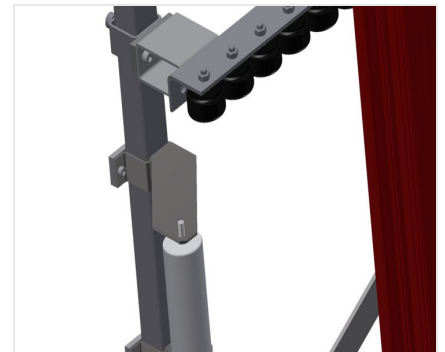

### Mini-roller conveyor height adjustment

Mini-roller conveyor height is adjustable





### End rack

End rack is mandatory at end of line

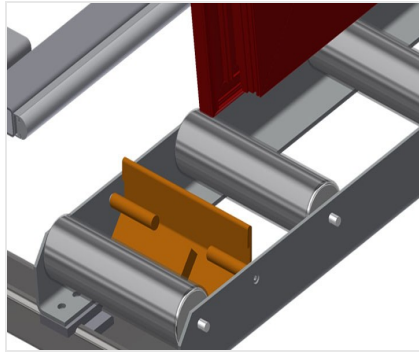

### End stop

End stop Rb = 200 mm for VR

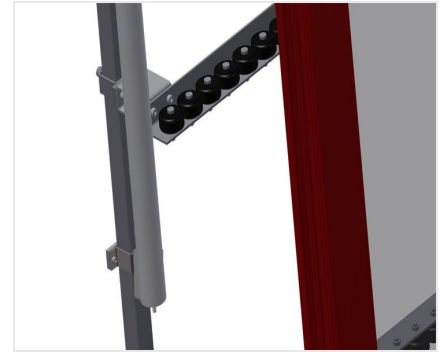

### Lead-in rollers

Protective rollers for beginning or end of roller conveyor L = 500 mm (pair) L = 250 mm (pair)



### Profile protectors

Profile protectors for support rollers 200 mm (Alum./11 x and Alum./16 x). Support rollers covered with protective tubing



### Additional mini-roller conveyors

Additional mini-roller conveyors with rubber rollers top/bottom





### VR 4000 / VERTICAL ROLLER CONVEYORS

---

- Length 4,000 mm
- Width 900 mm
- Height 2,400 mm
- Support roller width 200 mm
- Unit height 2,100 mm
- Load 200 kg
- Weight 200 kg