

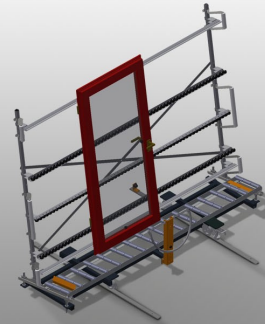

VR3003 F

VERTICAL ROLLER CONVEYORS



Vertical roller conveyor for transportation of window elements

- Stable steel construction
- Vertical roller conveyor for smooth transportation to the next work task as well as for transportation to storage and sorting of the finished windows
- Easy handling of window elements
- Every roller conveyor unit is 3,000 mm long
- Plastic slide bars top and bottom
- Three mini-roller conveyors with rubber rollers, diameter 50 mm
- Basic unit with end rack
- Vertical roller conveyor on rails with flanged rollers, mobile

Options

- Rail, 2.0 m, left and right
- End stop for VR
- Lead-in roller for VR
- Profile protectors for support rollers (Alum.)



Vertical roller conveyor VR 3003 F

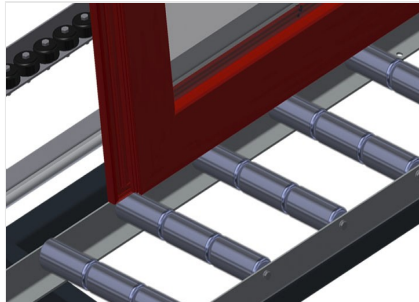

Support rollers

Rollers throughout, Roller conveyor divided into three parts, 3x 120 mm. Roller conveyor units, 2,000 mm, 3,000 mm and 4,000 mm long

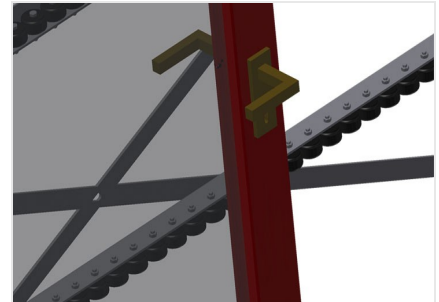

Mini-roller conveyor

Three mini-roller conveyors with rubber rollers, diameter 50 mm

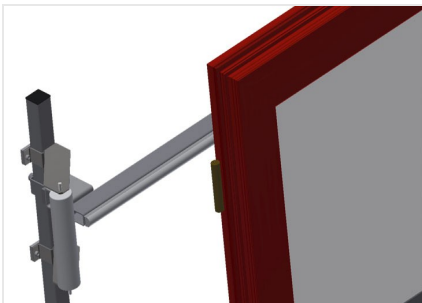

Back support

Rear back support with plastic slide bars, top and bottom

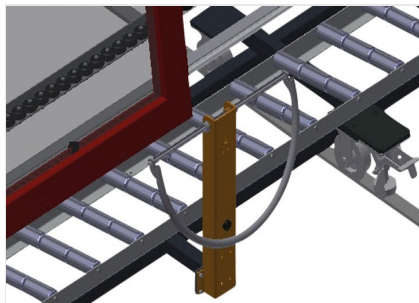

Grip

Grip makes pushing the roller conveyor on the rails easy



Mobility unit

Mobility unit with flanged rollers and fixing brake



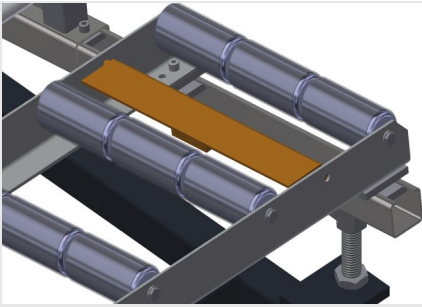

End stop

End stop Rb = 3x 120 mm

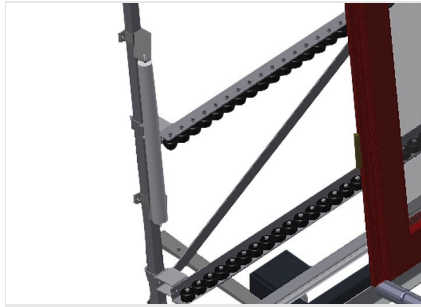

Lead-in rollers

Protective rollers for beginning or end of roller conveyor L = 500 mm (pair) L = 250 mm (pair)

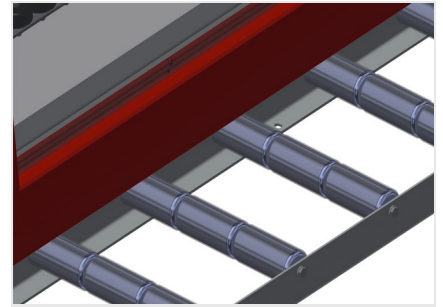

Profile protectors

Profile protectors for support rollers 3x 120 mm (Alum./33 x and Alum./48 x). Support rollers covered with protective tubing

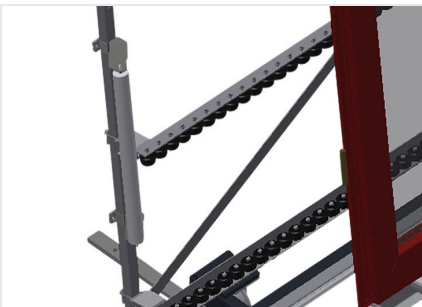

Additional mini-roller conveyors

Additional mini-roller conveyors with rubber rollers top/bottom





VR 3003 F / VERTICAL ROLLER CONVEYORS

- Length 3,000 mm
- Width 1,000 mm
- Height 2,490 mm
- Support rollers divided into three parts 3 x 120 mm
- Unit height 2,100 mm
- Load 200 kg
- Weight 180 kg