

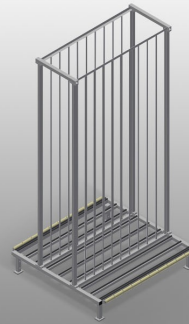

RFR10/02

Rack systems



Rack for storage of frame elements

- Stable steel construction
- Rack for storage of frames
- The individual elements are available for direct access
- Specially designed for integration in assembly lines
- Access is possible from both sides
- Floor support equipped with knob profile
- Compartment separating bars covered with protective tubing
- Supporting surface with rollers for even easier loading and unloading



Frame rack RFR 10/02



Compartments

All supporting surfaces have a non-slip PVC cladding which protects surfaces from damage during storage

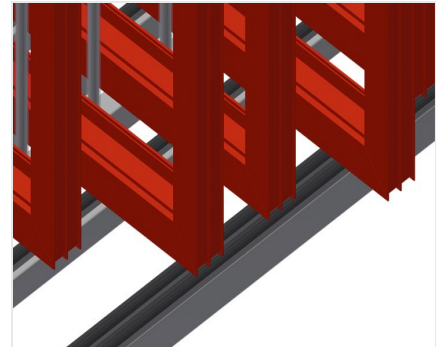

Supports

Lower supporting surfaces with knob profile to protect profiles from damage

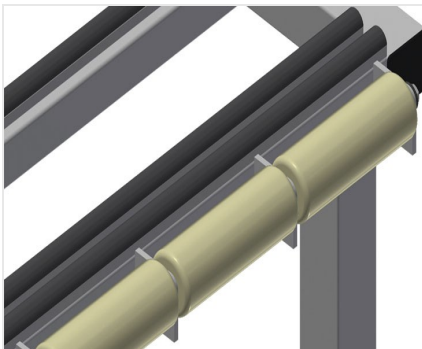

Rollers

Rollers are mounted to every compartment for even easier loading and unloading of heavy or large elements





RFR 10/02 / RACK SYSTEMS

- Length 1,50 mm
- Width 1,620 mm
- Height 3,375 mm
- Ten compartments
- Compartment width 160 mm
- Compartment height 3,010 mm
- Weight 275 kg
- Load 800 kg